

A large, stylized, light yellow number '5' is centered on the page. It has a thick, rounded font style with a slight shadow effect.

Section 5 > Miscellaneous

5

Miscellaneous signage > Table of contents



- Construction sign115
- Banners116
- Boundary banners120
- Boundary markers121
- Table covers126
- Dedication and donor plaques129
- Decals134

Building name: Univers 47 Condensed Light (fit for name of building)

Lot letters: Univers 75 Black and Univers 47 Condensed Light (fit for information amount)

VCU logotype: Univers 75 Black (see drawing for size)
-15/-96 kerning between the "V" and "C" and -10/-62 between the "C" and "U"

Construction sign

Mount: Varies

Copy: Black

VCU logotype: Color match for VCU yellow is PMS 130C

Building name: White

VCU bar: Univers 75 Black (.927" letters)

Black bar with "Virginia Commonwealth University" letter forms knocked out to let light cream white of current backgrounds through or use white.

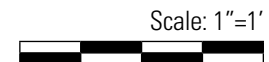
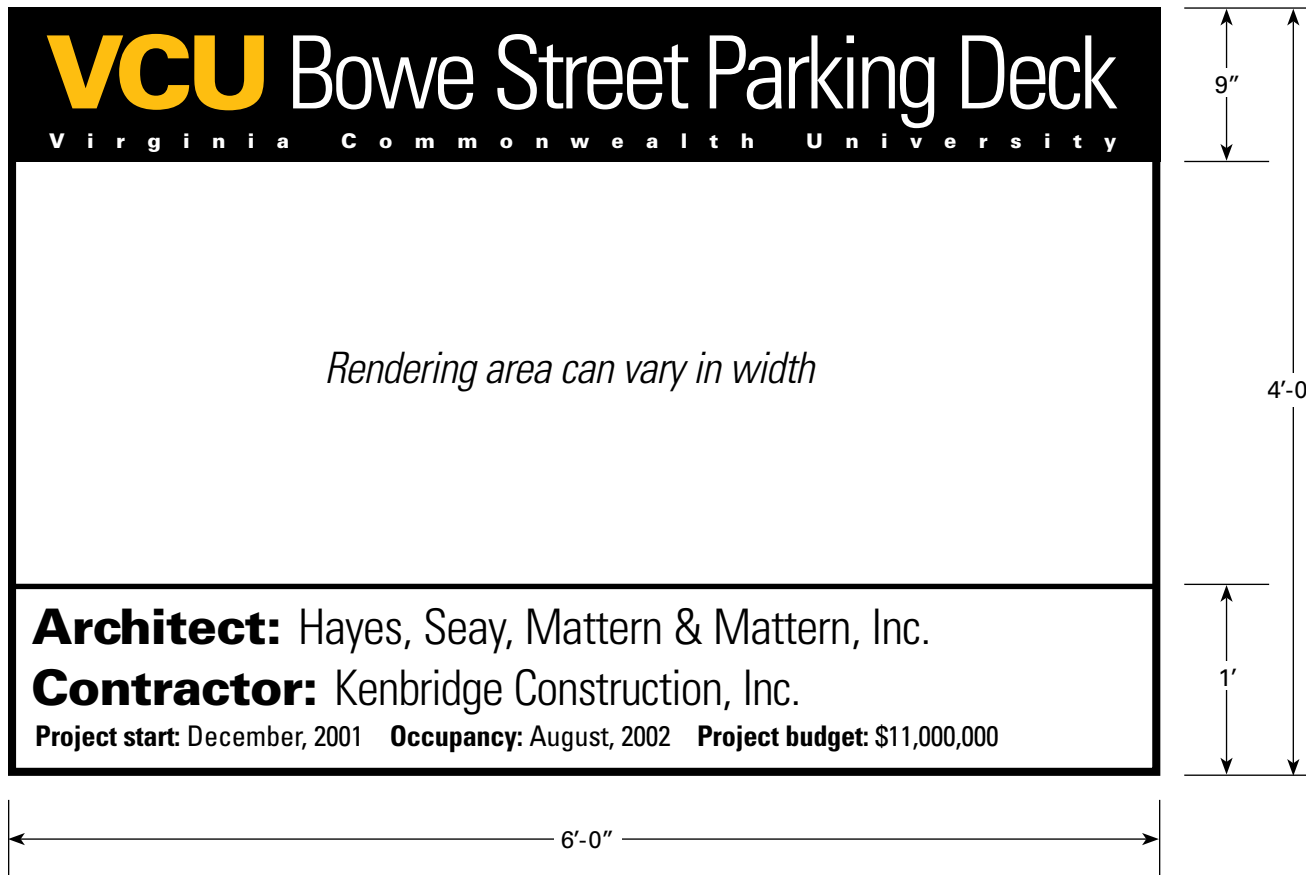

Banners

Size: 40' x 5'

Material: Vinyl

Color: One-, two- and four-color process

Display: Insert several grommets throughout starting at upper left-hand corner and ending at upper right-hand corner; include ties

Service Learning • African Crafts Project

VCU L. Douglas Wilder School of Government and Public Affairs

V i r g i n i a C o m m o n w e a l t h U n i v e r s i t y

Display: Insert several grommets throughout starting at upper left-hand corner and ending at upper right-hand corner; include ties

Banners

Size: 40' x 5'

Material: Vinyl

Color: One-, two- and four-color process



Banners

Size: 3' x 5'

Material: Sunbrella

Color: Black two-sided fabric with
two-color VCU logo

Display: Pocket at top

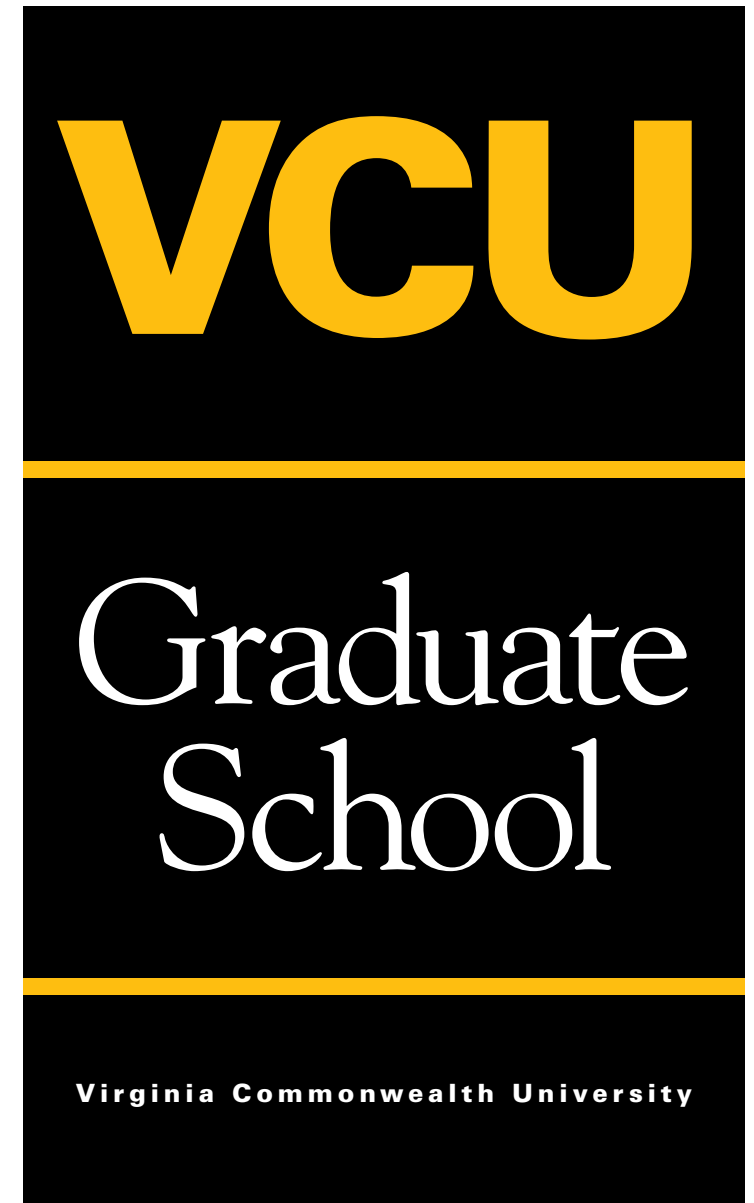



Banners

Size: 30" x 60"

Material: Sunbrella

Color: Four-color process; prints on both sides; bleeds on all sides

Display: Pockets at top and bottom

Boundary banners

Size: 2' x 3.5'

Material: Sunbrella

Color: Black fabric; four-color process

Display: Pockets at top and bottom

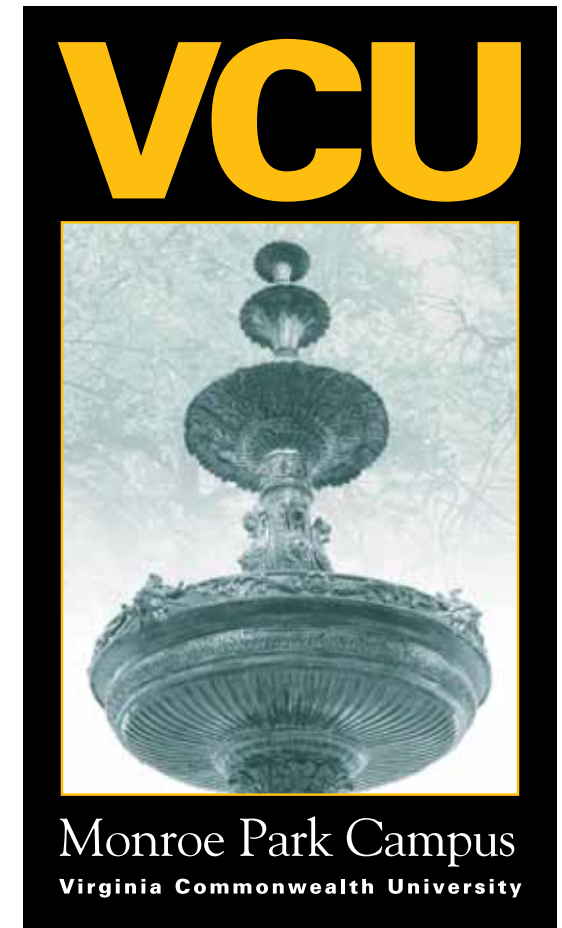
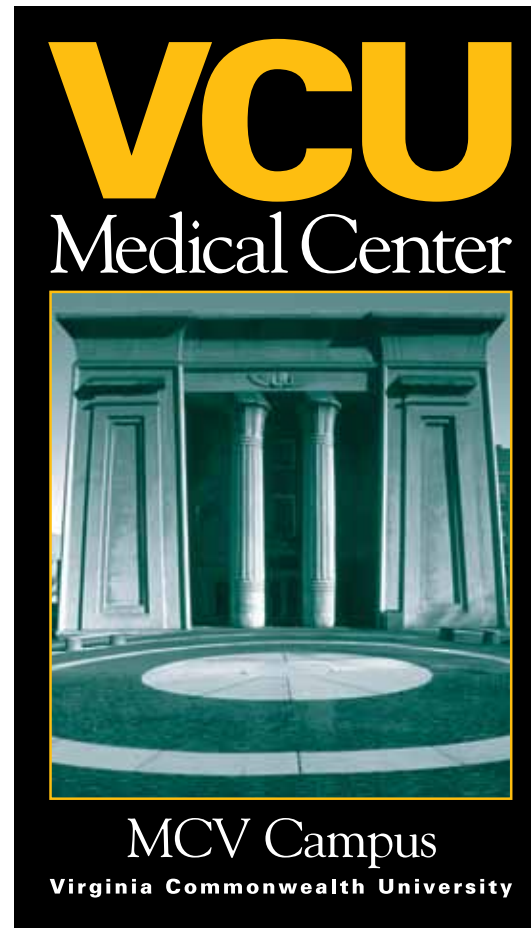

VCU
Virginia Commonwealth University
Medical Center

MCV Campus



VCU
Virginia Commonwealth University
Monroe Park Campus



Boundary markers

Refer to specifications on pages 121 and 125.

Section 5 > **Miscellaneous signage** > Boundary markers

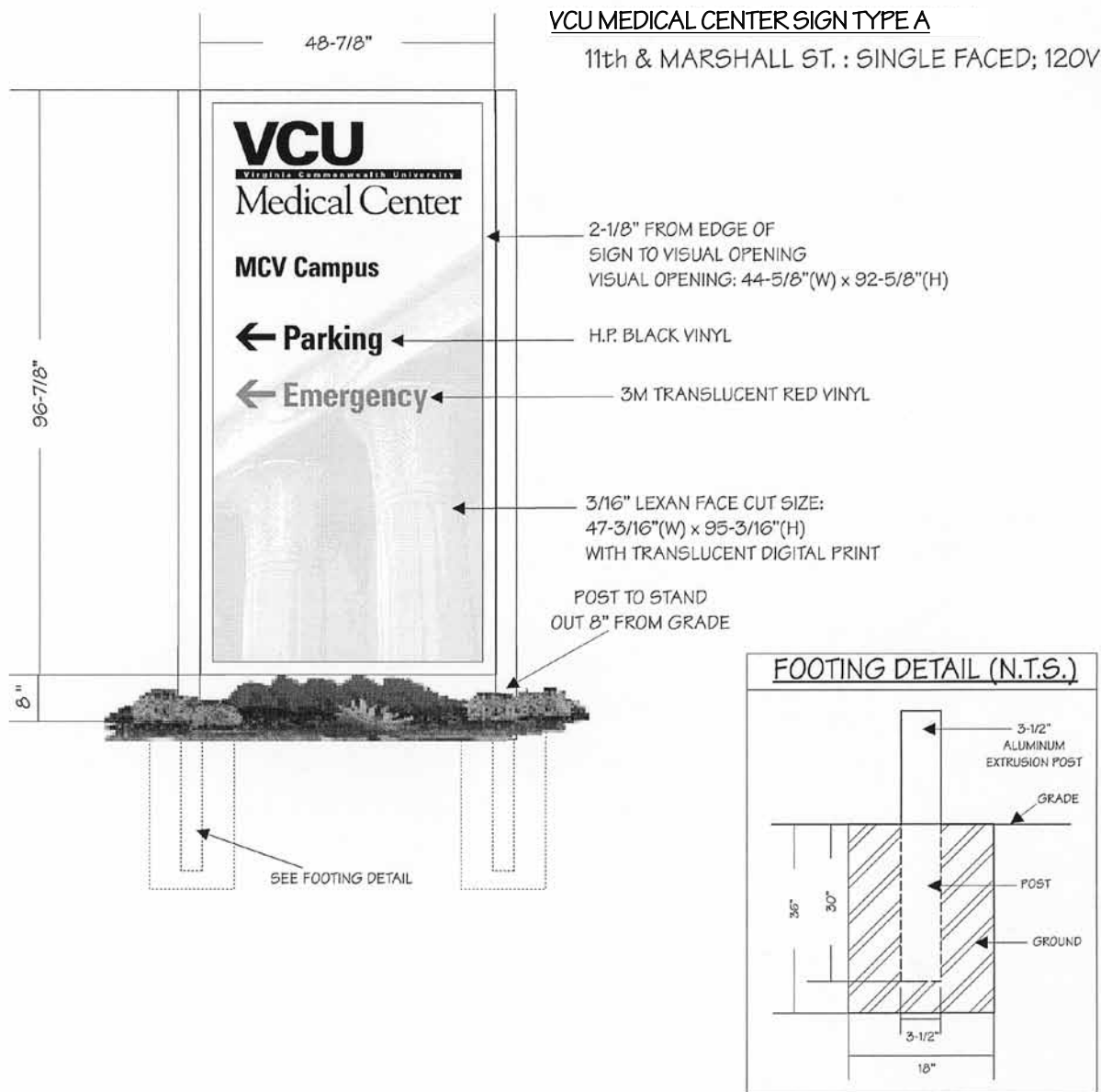

Boundary markers

(1) 8'(H) x 4' (W) Illuminated exterior extrusion signs.

Signs are to have radius ends using (2) 3-1/2" 1/4 round ends (series 7 #1670). Radius ends to have caps on top.

Extrusion is to be 7" bleed body (series 7 # 1580).

Retainers are 1-3/4" excellart (ZF-188).

(8) Fluorescent lamps are to run horizontally 120V power supply.

Faces are white 3/16" lexan with vinyl copy and graphics.

Single-face signs are to have .080 aluminum back.

Footing should be 3' in ground from grade.

Boundary markers

(3) 8'(H) x 4' (W) Illuminated exterior extrusion signs.

Signs are to have radius ends using (2)3-1/2" 1/4 round ends (series 7 #1670). Radius ends to have caps on top.

Extrusion is to be 7" bleed body (series 7 # 1580).

Retainers are 1-3/4" excellart (ZF-188).

(8) Fluorescent lamps are to run horizontally 120V power supply.

Faces are white 3/16" lexan with vinyl copy and graphics.

Single-face signs are to have .080 aluminum back.

Footing should be 3' in ground from grade.

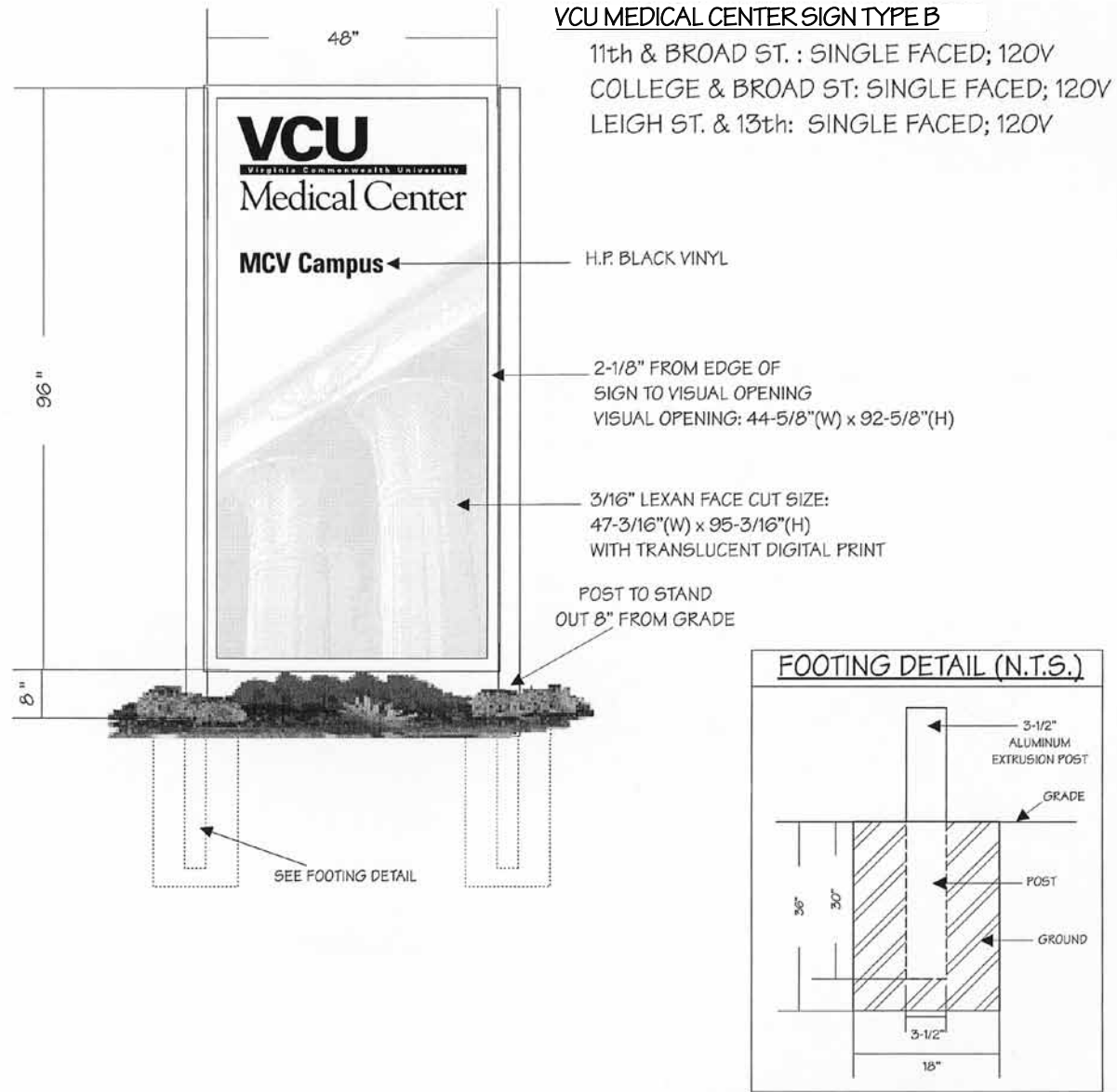

Section 5 > **Miscellaneous signage** > Boundary markers

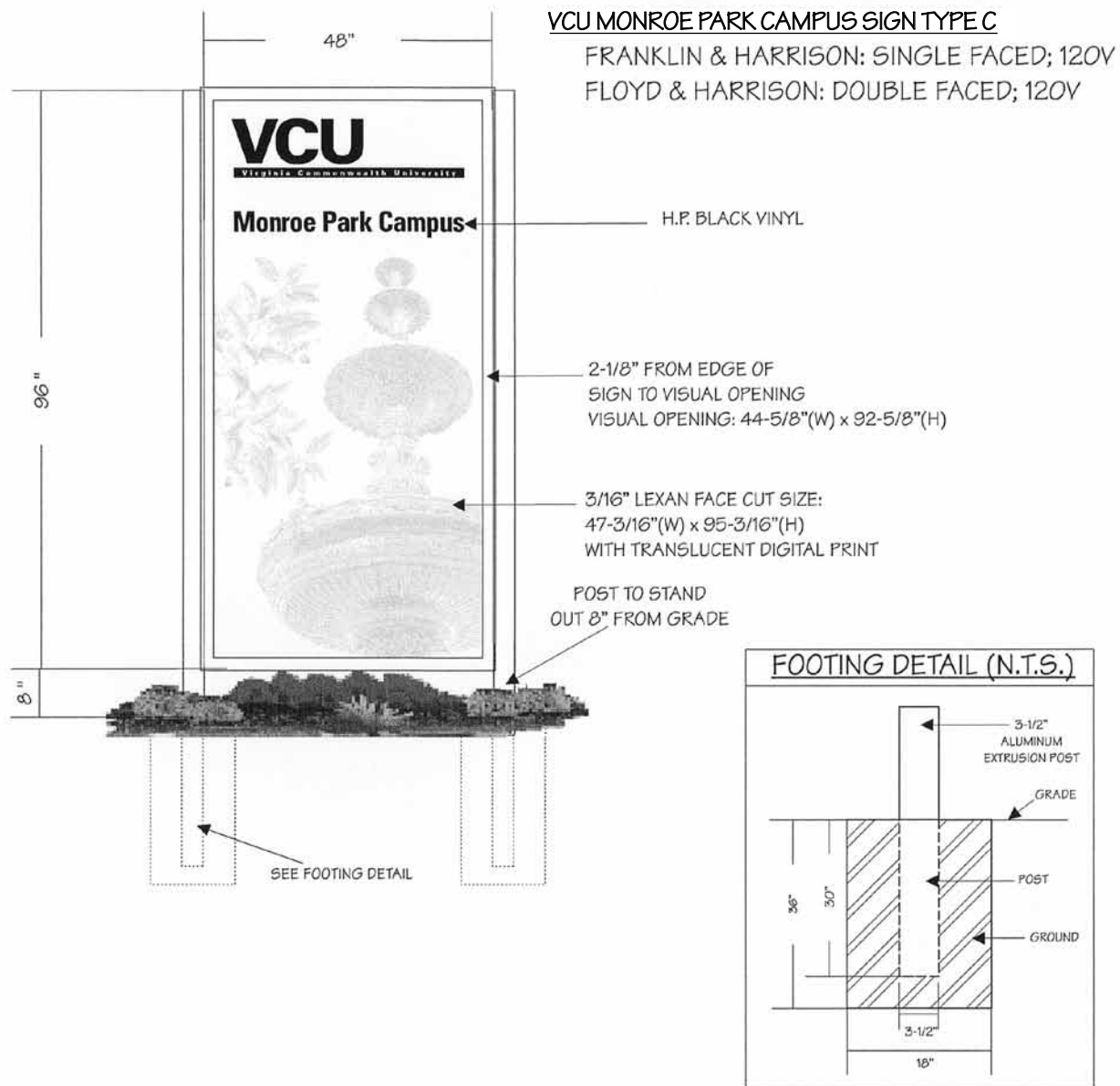

Boundary markers

(2) 8'(H) x 4'(W) Illuminated exterior extrusion signs.

Signs are to have radius ends using (2) 3-1/2" 1/4 round ends (series 7 #1670). Radius ends to have caps on top.

Extrusion is to be 7" bleed body (series 7 # 1580).

Retainers are 1-3/4" excellart (ZF-188).

(8) Fluorescent lamps are to run horizontally 120V power supply.

Faces are white 3/16" lexan with vinyl copy and graphics.

Single-face signs are to have .080 aluminum back.

Footing should be 3' in ground from grade.

Boundary markers

(6) 8'(H) x 4'(W) Illuminated exterior extrusion signs.

Signs are to have radius ends using (2) 3-1/2" 1/4 round ends (series 7 #1670). Radius ends to have caps on top.

Extrusion is to be 7" bleed body (series 7 # 1580).

Retainers are 1-3/4" excellart (ZF-188).

(8) Flourescent lamps are to run horizontally 120V power supply.

Faces are white 3/16" lexan with vinyl copy and graphics.

Single-face signs are to have .080 aluminum back.

Footing should be 3' in ground from grade.

CONSTRUCTION DETAIL

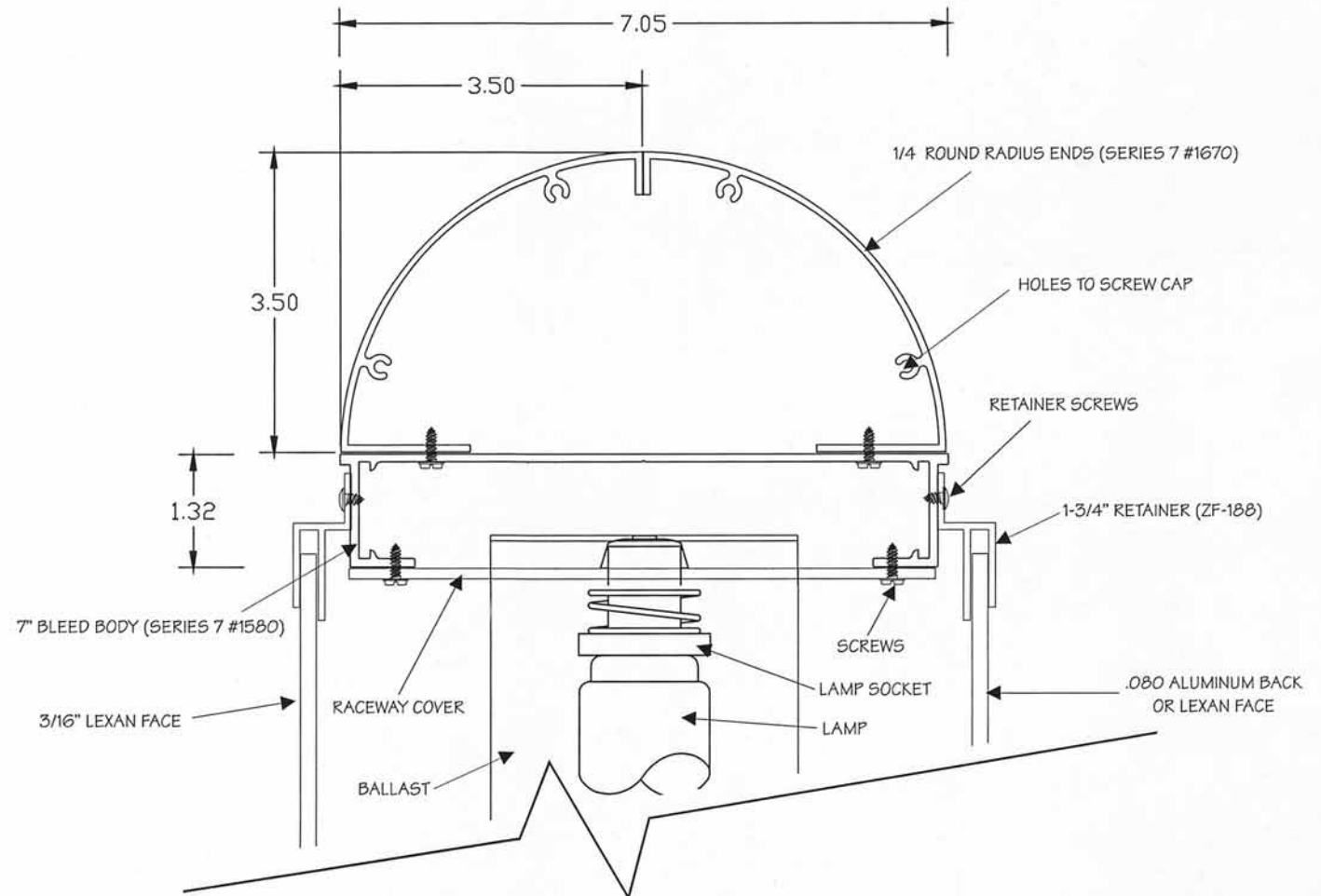

Table covers

Size: 4', 6' or 8'

Material: Black fabric

Color: Black cloth with two-color
VCU logotype and bar

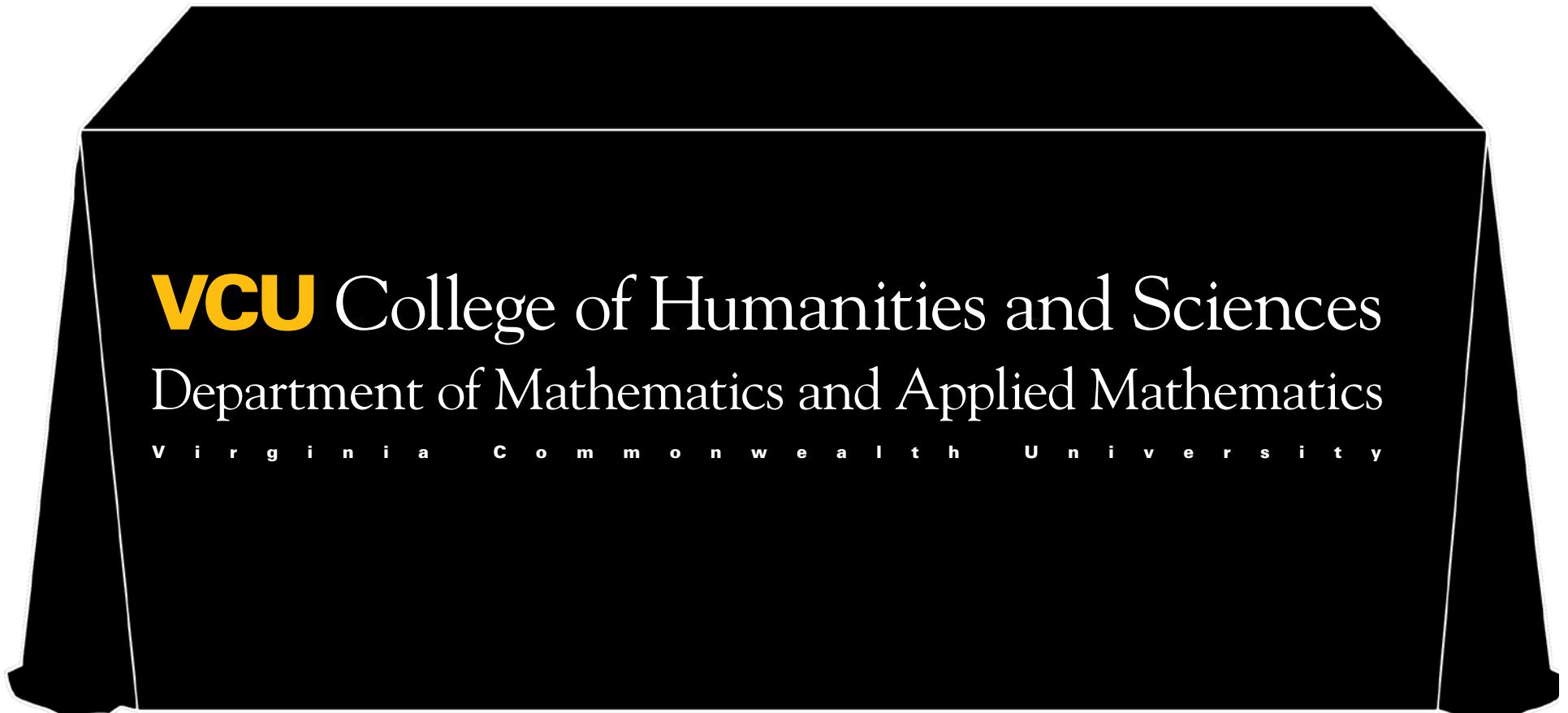

Table covers

Size: 4', 6' or 8'

Material: Black fabric

Color: Black cloth with two-color
VCU logotype and bar



Section 5 > Miscellaneous signage > Plaques

Dedication and donor plaques

Acknowledges a building or item that has been donated by or dedicated to a person or group of persons.

The plaque is treated in an individual manner. Specifications have been deliberately limited to give guidelines but not restrict creativity. Generally, some form of the university signature appears on each plaque. The Office of University Advancement administers the approval process for dedication and donor plaques. For further information, contact the Office of University Advancement at (804) 828-0783. In general, the university is very selective in its policies regarding the naming of rooms or buildings constructed with donated funds.

Color: Consider surrounding environment and nature of item designated.

Location is dependent on nature of item designated. When acknowledging an architectural space, place plaque inside area to be identified, not at the entrance. Do not group with other sign types. Follow standard heights listed for similar sizes of sign panels.

Suit messages to the nature of the donated area or item; use dignity and good taste in wording.

Board of Visitors:

List officers first, followed by remaining members in alphabetical order. Do not use courtesy titles (i.e., Mr., Dr., The Honorable).

Building name: Univers 67 Bold Condensed; 86.185 pt.; -10 tracking

Opened month: Univers 65 Bold; 51.711 pt.; -10 tracking

VCU logotype: Univers 75 Black; 152.349 pt.; -15/-96 kerning between the "V" and "C" and -10/-62 between the "C" and "U"

VCU bar: Univers 75 Black; 37.35 pt.; 452 tracking
Pres and BOV: Univers 67 Bold Condensed; 37.35 pt.; -10 tracking

Names: Univers 67 Bold Condensed; 37.35 pt.; 44.5 leading-10 tracking

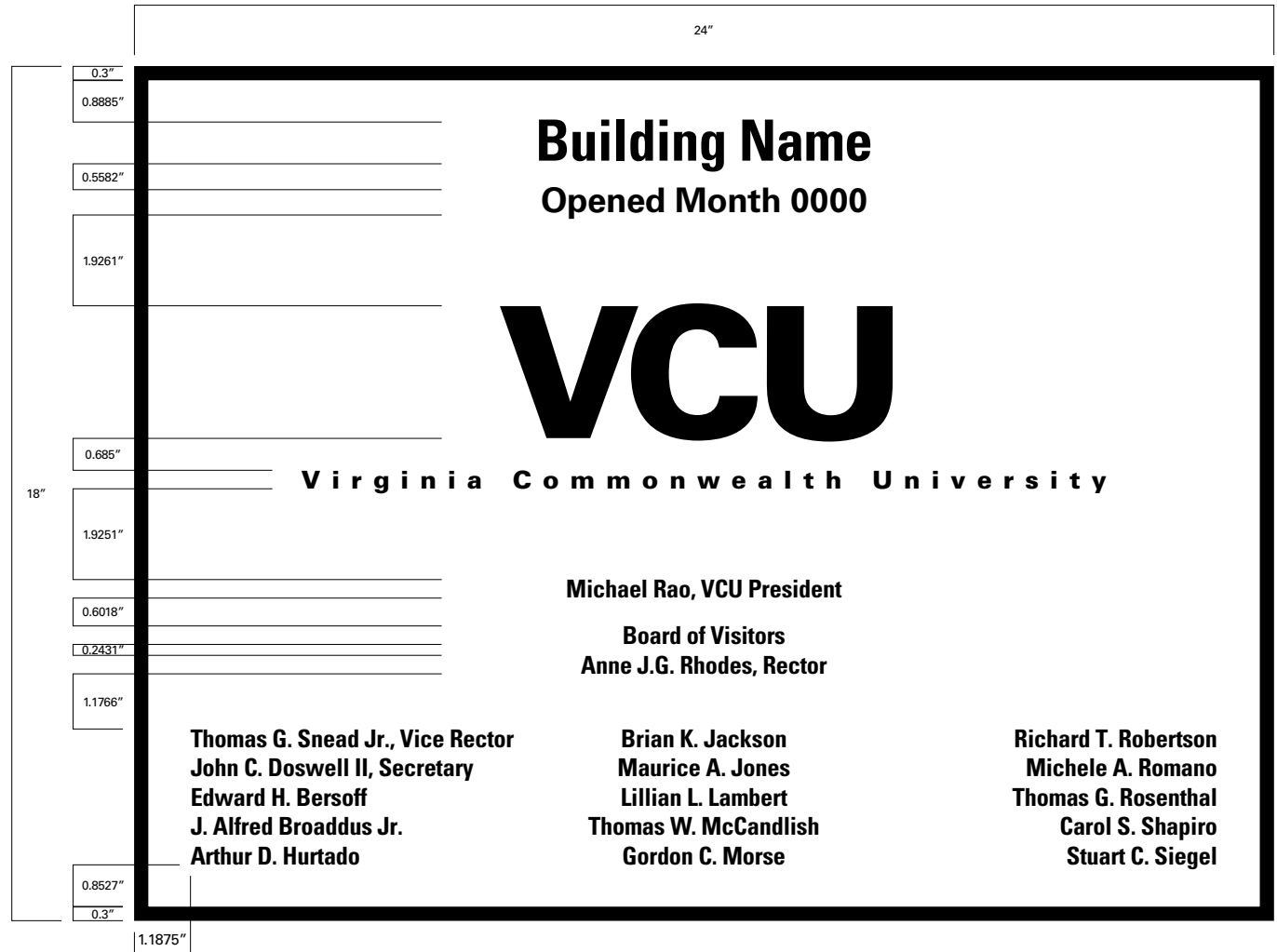

Building name: Univers 67 Bold Condensed; 86.185 pt.; -10 tracking

Opened month: Univers 65 Bold; 51.711 pt.; -10 tracking

VCU logotype: Univers 75 Black; 152.349 pt.;
-15/-96 kerning between the "V" and "C"
and -10/-62 between the "C" and "U"

Medical center: Goudy Old Style; 156.253 pt.;
-95 kerning between the "M" and "e",
-16 kerning between the "e" and "d",
-53 kerning between the "d" and "i",
-70 kerning between the "i" and "c",
-21 kerning between the "c" and "a",
-35 kerning between the "a" and "l",
245 kerning between the "l" and "C",
-15 kerning between the "C" and "e",
-40 kerning between the "e" and "n",
-80 kerning between the "n" and "t",
-55 kerning between the "t" and "e",
-49 kerning between the "e" and "r"

VCU bar: Univers 75 Black; 37.35 pt.; 452 tracking

Pres and BOV: Univers 67 Bold Condensed
37.35 pt.; -10 tracking

Names: Univers 67 Bold Condensed
37.35 pt.; 44.5 leading-10 tracking

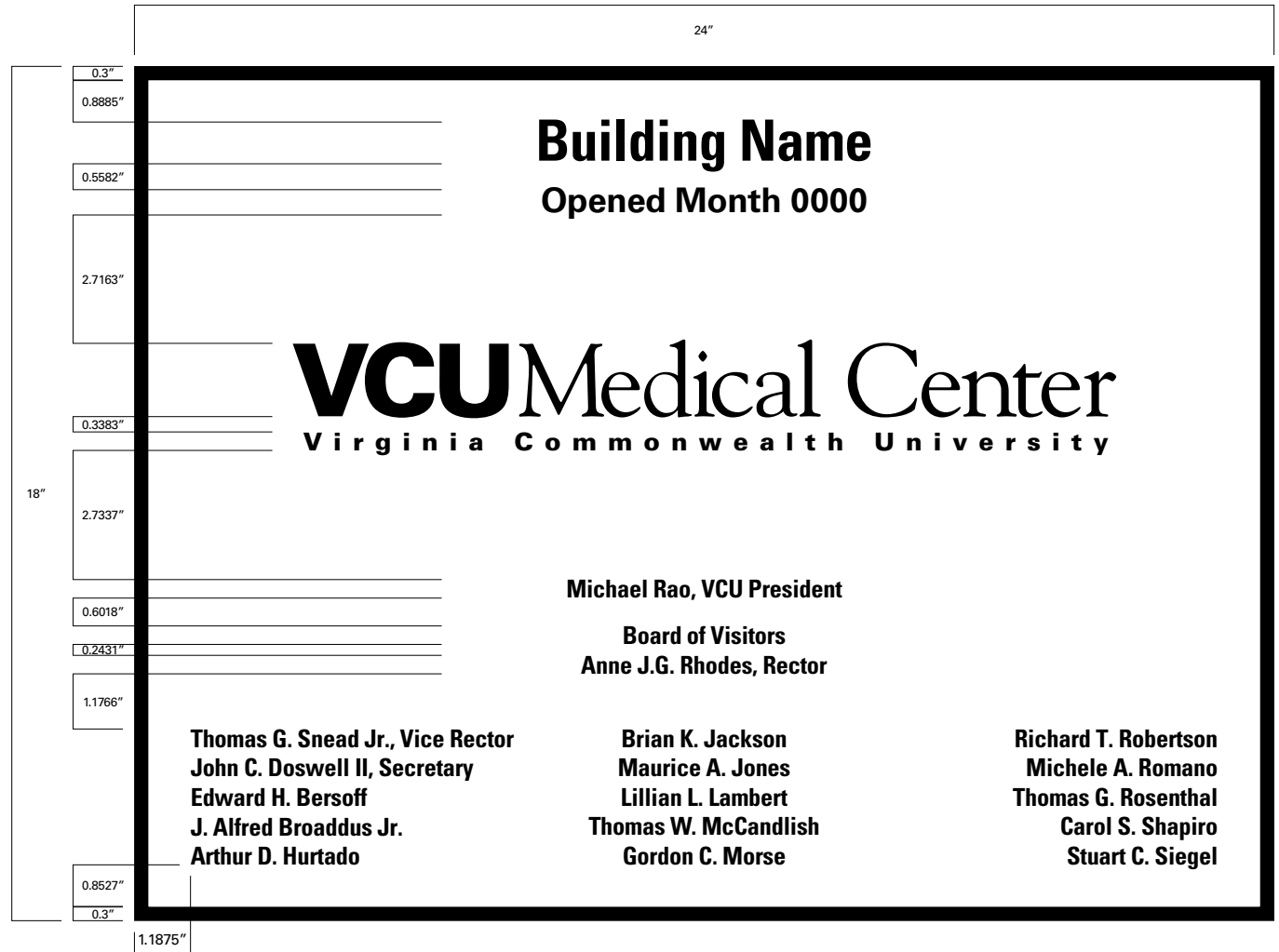

Section 5 > Miscellaneous signage > Plaques

Dedication and donor plaques

Acknowledges a building or item that has been donated by or dedicated to a person or group of persons.

The plaque is treated in an individual manner. Specifications have been deliberately limited to give guidelines but not restrict creativity. Generally, some form of the university signature appears on each plaque. The Office of University Advancement administers the approval process for dedication and donor plaques. For further information, contact the Office of University Advancement at (804) 828-0783. In general, the university is very selective in its policies regarding the naming of rooms or buildings constructed with donated funds.

Color: Consider surrounding environment and nature of item designated.

Location is dependent on nature of item designated. When acknowledging an architectural space, place plaque inside area to be identified, not at the entrance. Do not group with other sign types. Follow standard heights listed for similar sizes of sign panels.

Suit messages to the nature of the donated area or item; use dignity and good taste in wording.

Board of Visitors:

List officers first, followed by remaining members in alphabetical order. Do not use courtesy titles (i.e., Mr., Dr., The Honorable).

Building name: Univers 67 Bold Condensed; 86.185 pt.; -10 tracking

Opened month: Univers 65 Bold; 51.711 pt.; -10 tracking

VCU logotype: Univers 75 Black; 152.349 pt.; -15/-96 kerning between the "V" and "C" and -10/-62 between the "C" and "U"

VCU bar: Univers 75 Black; 37.35 pt.; 452 tracking

Contribution: Univers 67 Bold Condensed 37.35 pt.; -10 tracking

Pres and BOV: Univers 67 Bold Condensed 37.35 pt.; -10 tracking

Rule: 2 pt. black rule

Names: Univers 67 Bold Condensed 37.35 pt.; 44.5 leading-10 tracking

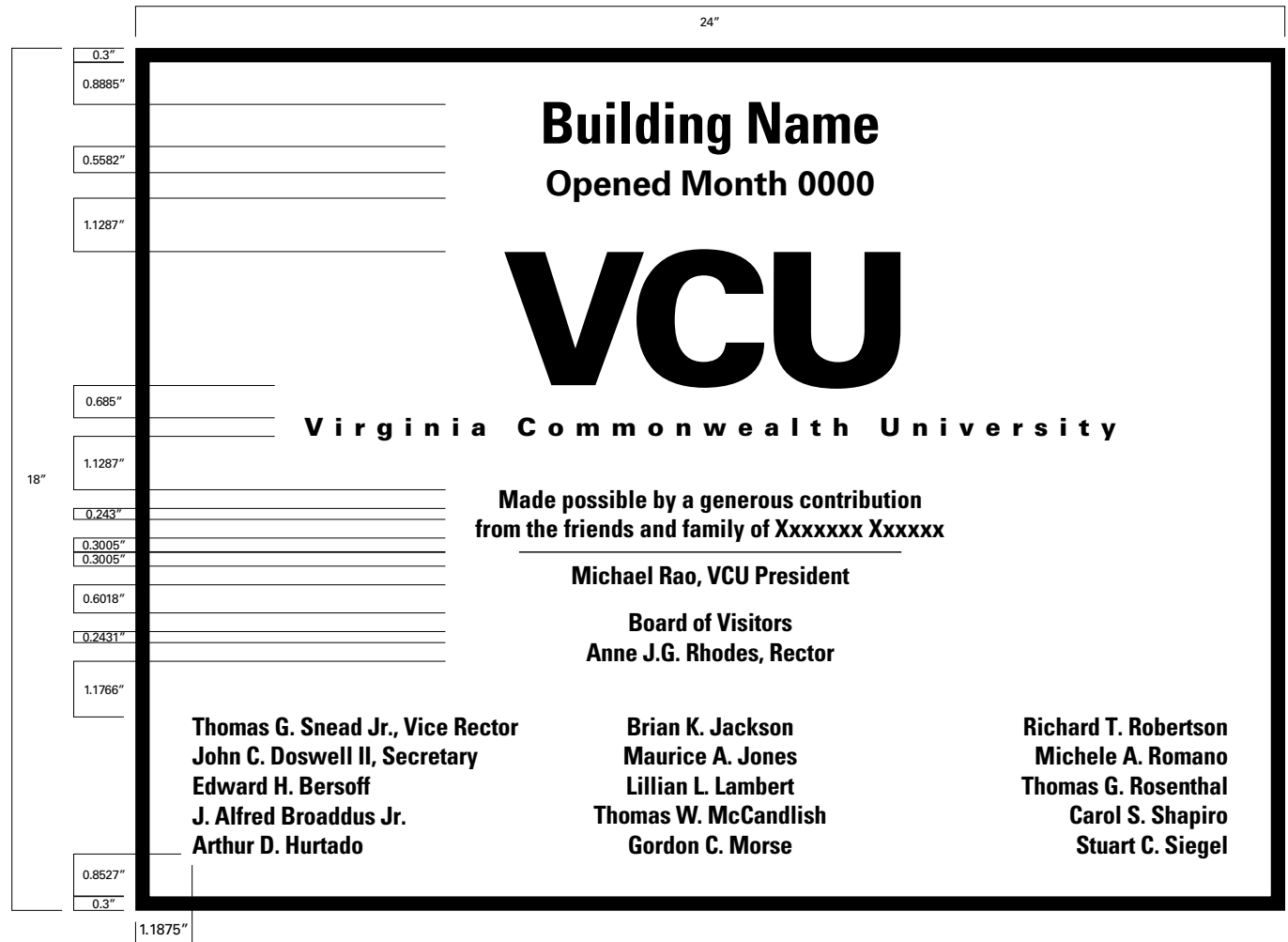

Building name: Univers 67 Bold Condensed; 86.185 pt.; -10 tracking

Opened month: Univers 65 Bold; 51.711 pt.; -10 tracking

VCU logotype: Univers 75 Black; 152.349 pt.;
-15/-96 kerning between the "V" and "C"
and -10/-62 between the "C" and "U"

Medical center: Goudy Old Style; 156.253 pt.;
-95 kerning between the "M" and "e",
-16 kerning between the "e" and "d",
-53 kerning between the "d" and "l",
-70 kerning between the "i" and "c",
-21 kerning between the "c" and "a",
-35 kerning between the "a" and "l",
245 kerning between the "l" and "C",
-15 kerning between the "C" and "e",
-40 kerning between the "e" and "n",
-80 kerning between the "n" and "t",
-55 kerning between the "t" and "e",
-49 kerning between the "e" and "r"

VCU bar: Univers 75 Black; 37.35 pt.; 452 tracking

Contribution: Univers 67 Bold Condensed
37.35 pt.; -10 tracking

Pres and BOV: Univers 67 Bold Condensed
37.35 pt.; -10 tracking

Rule: 2 pt. black rule

Names: Univers 67 Bold Condensed
37.35 pt.; 44.5 leading-10 tracking

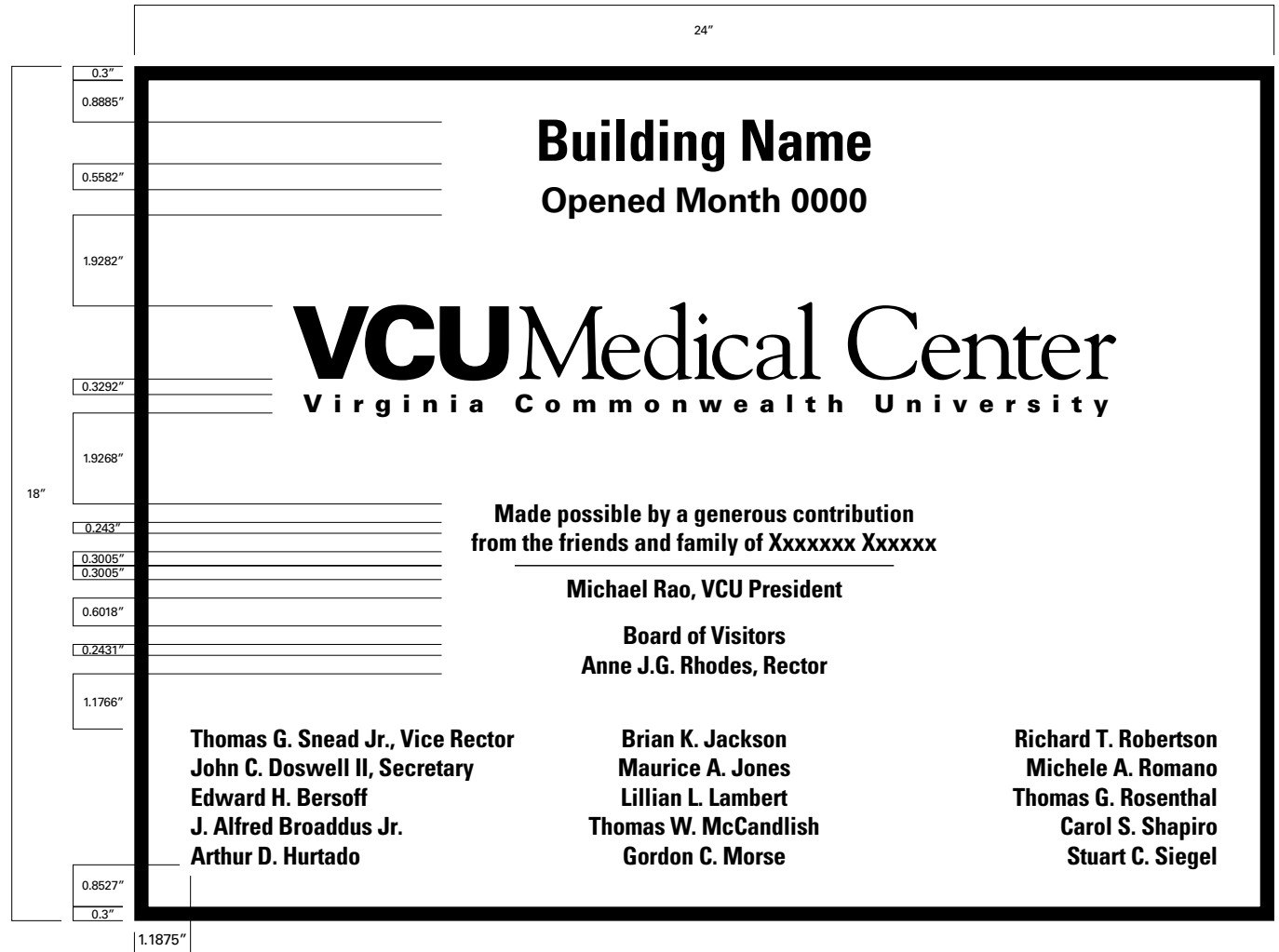

Section 5 > Miscellaneous signage > Plaques

Dedication and donor plaques

Acknowledges a building or item that has been donated by or dedicated to a person or group of persons.

The plaque is treated in an individual manner. Specifications have been deliberately limited to give guidelines but not restrict creativity. Generally, some form of the university signature appears on each plaque. The Office of University Advancement administers the approval process for dedication and donor plaques. For further information, contact the Office of University Advancement at (804) 828-0783. In general, the university is very selective in its policies regarding the naming of rooms or buildings constructed with donated funds.

Color: Consider surrounding environment and nature of item designated.

Location is dependent on nature of item designated. When acknowledging an architectural space, place plaque inside area to be identified, not at the entrance. Do not group with other sign types. Follow standard heights listed for similar sizes of sign panels.

Suit messages to the nature of the donated area or item; use dignity and good taste in wording.

Board of Visitors:

List officers first, followed by remaining members in alphabetical order. Do not use courtesy titles (i.e., Mr., Dr., The Honorable).

Building name: Univers 67 Bold Condensed; 86.185 pt.; -10 tracking

Opened month: Univers 65 Bold; 51.711 pt.; -10 tracking

VCU logotype: Univers 75 Black; 152.349 pt.; -15/-96 kerning between the "V" and "C" and -10/-62 between the "C" and "U"

VCU bar: Univers 75 Black; 37.35 pt.; 452 tracking
Pres and BOV: Univers 67 Bold Condensed; 37.35 pt.; -10 tracking

Names: Univers 67 Bold Condensed; 37.35 pt.; 44.5 leading-10 tracking

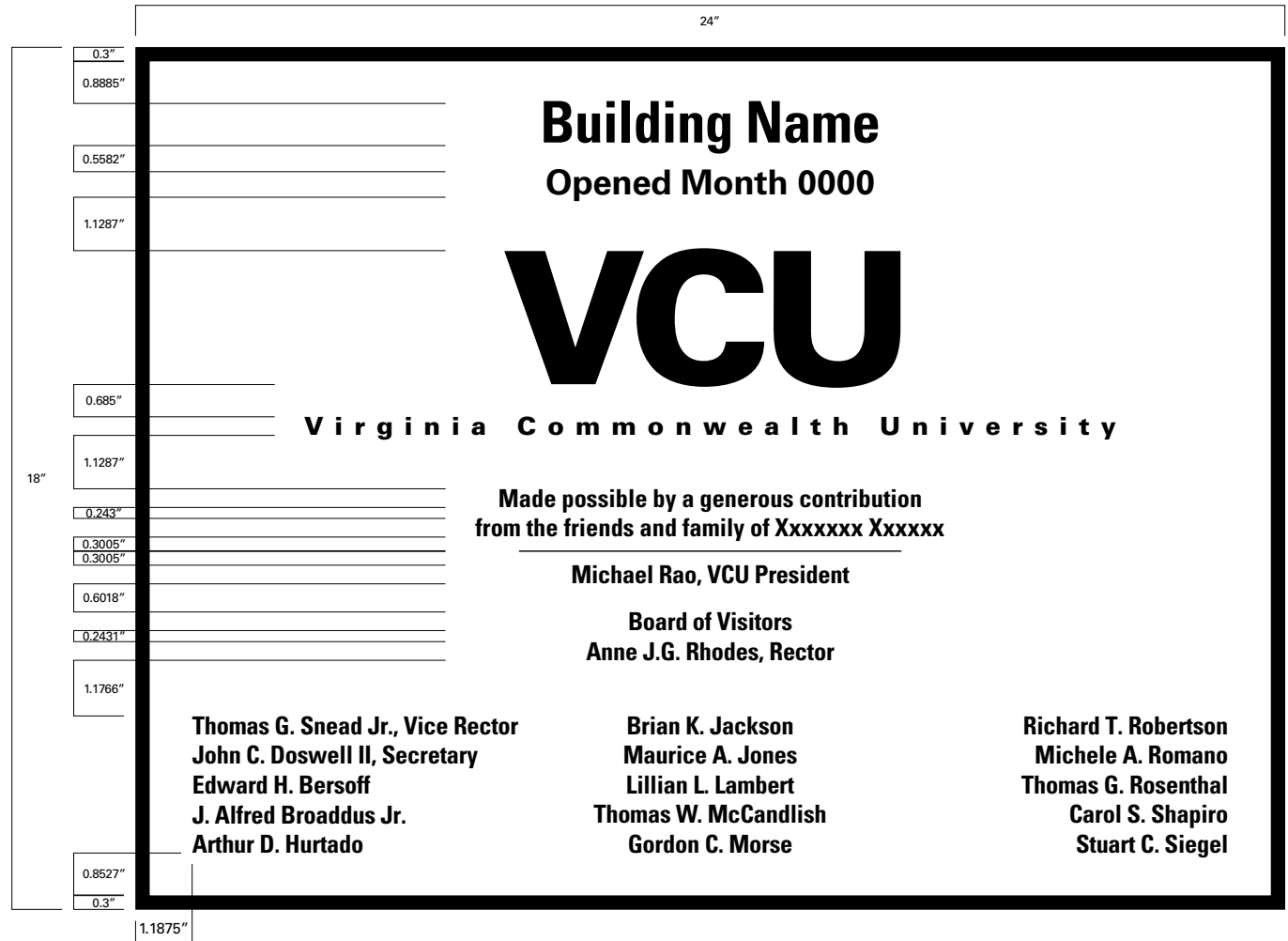

Building name: Univers 67 Bold Condensed; 86.185 pt.; -10 tracking

Opened month: Univers 65 Bold; 51.711 pt.; -10 tracking

VCU logotype: Univers 75 Black; 152.349 pt.;
-15/-96 kerning between the "V" and "C"
and -10/-62 between the "C" and "U"

Medical center: Goudy Old Style; 156.253 pt.;
-95 kerning between the "M" and "e",
-16 kerning between the "e" and "d",
-53 kerning between the "d" and "l",
-70 kerning between the "i" and "c",
-21 kerning between the "c" and "a",
-35 kerning between the "a" and "l",
245 kerning between the "l" and "C",
-15 kerning between the "C" and "e",
-40 kerning between the "e" and "n",
-80 kerning between the "n" and "t",
-55 kerning between the "t" and "e",
-49 kerning between the "e" and "r"

VCU bar: Univers 75 Black; 37.35 pt.; 452 tracking

Contribution: Univers 67 Bold Condensed
37.35 pt.; -10 tracking

Pres and BOV: Univers 67 Bold Condensed
37.35 pt.; -10 tracking

Rule: 2 pt. black rule

Names: Univers 67 Bold Condensed
37.35 pt.; 44.5 leading-10 tracking

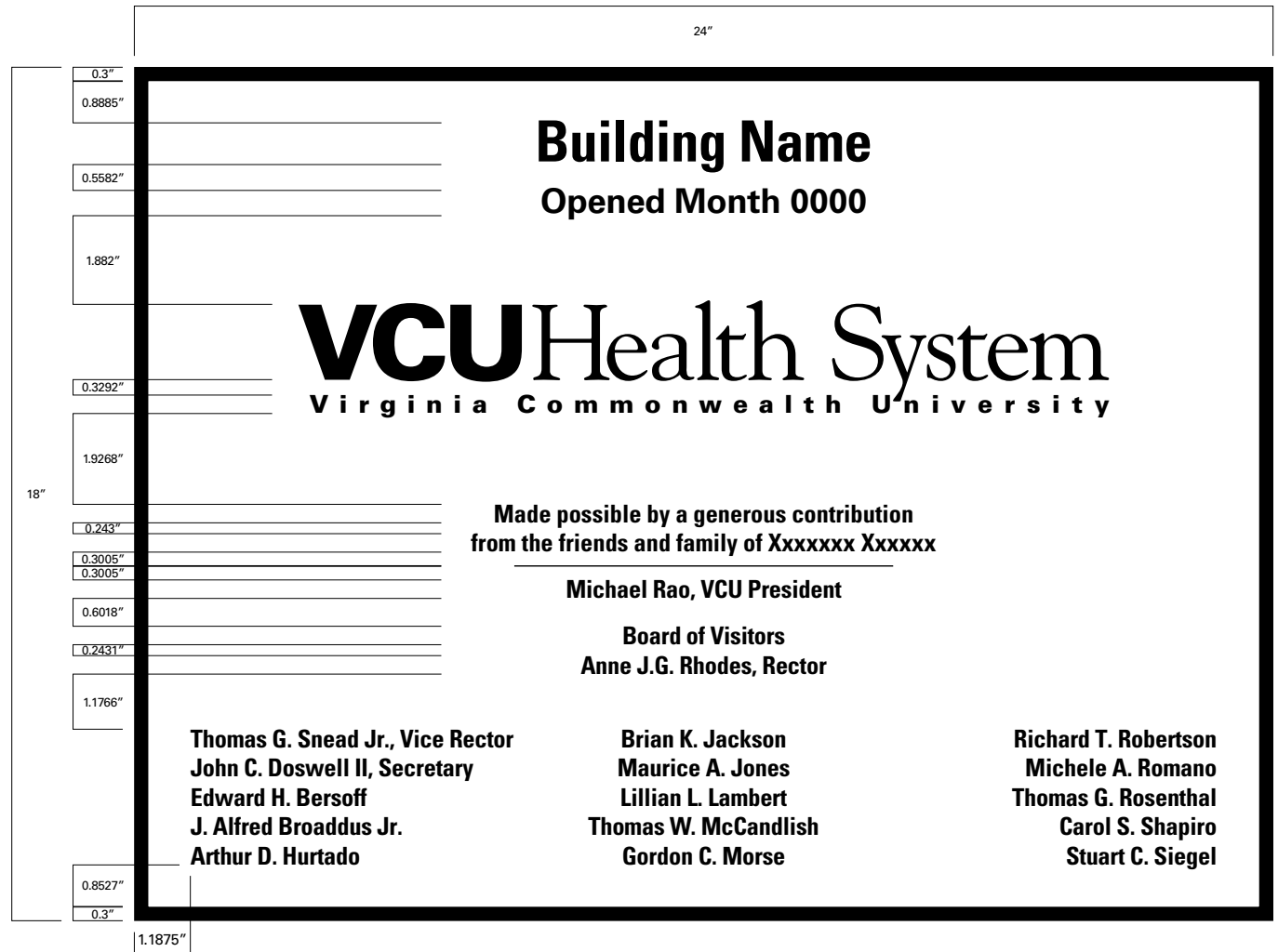

Decals

Decals should be used on glass where the architecture of interior space is not appropriate for a sign panel.

Decals should not be used on exterior Plexiglas since solar exposure may cause warping.

Copy: For type size refer to sign type represented; white vinyl on dark surfaces, black vinyl on light surfaces.

May use the official university seal as a safety device so that visitors and staff will be aware of glass and avoid accidents.



Scale: 1/2"=1"

